

FAG

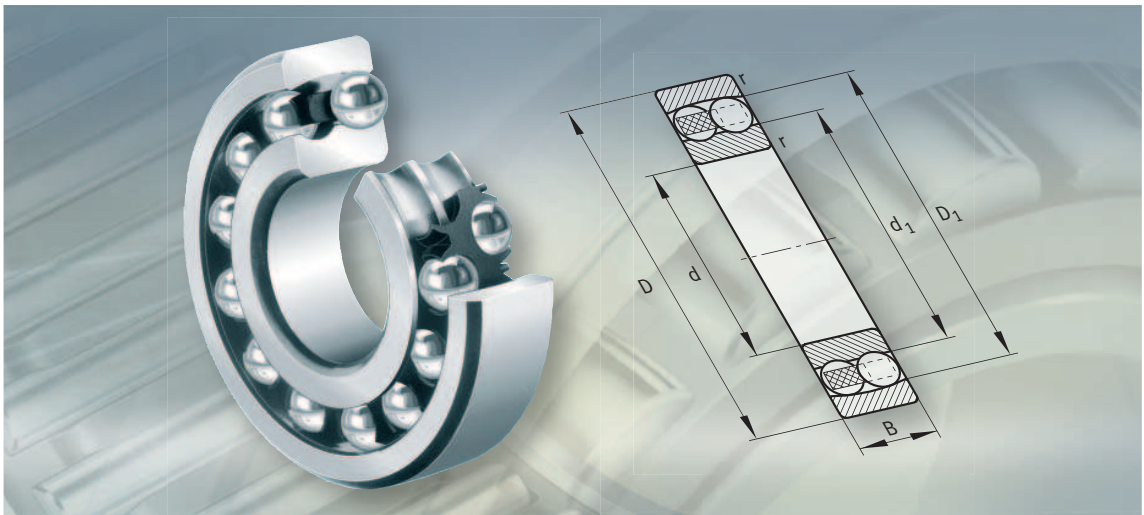

Self-aligning ball bearings

Self-aligning ball bearings

	Page
Product overview	Self-aligning ball bearings 326
Features	Radial and axial load capacity 327
	Compensation of angular misalignments 327
	Operating temperature 327
	Cages 328
	Suffixes 328
Design and safety guidelines	Equivalent dynamic bearing load 329
	Equivalent static bearing load 329
	Minimum load 329
	Speeds 329
	Mounting dimensions 329
	Projecting balls in bearings with brass cage 330
	Location 330
Accuracy	Radial internal clearance of bearings with cylindrical bore 331
	Radial internal clearance of bearings with tapered bore 331
Dimension tables	Self-aligning ball bearings, cylindrical bore 332
	Self-aligning ball bearings, cylindrical or tapered bore 334
	Self-aligning ball bearings, with extended inner ring 346
	Self-aligning ball bearings, with adapter sleeve 348



Product overview Self-aligning ball bearings

With cylindrical or tapered bore

10, 12, 13,
22, 23

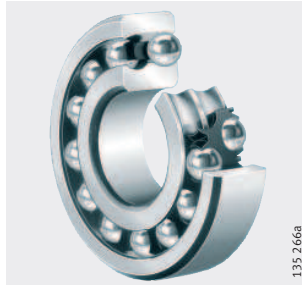

12...-K, 13...-K,
22...-K, 23...-K

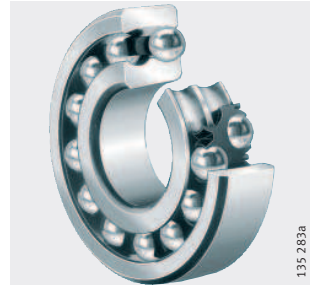

Lip seals

22...-2RS, 22...-K-2RS,
23...-2RS

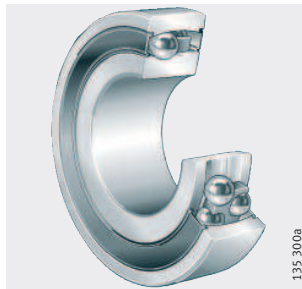

With adapter sleeve
Without or with lip seals

12...-K + H, 13...-K + H
22...-K + H, 23...-K + H

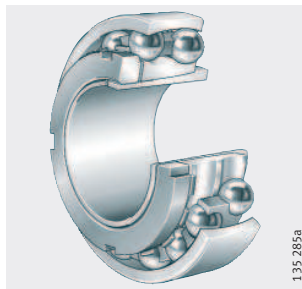

22...-K-2RS + H

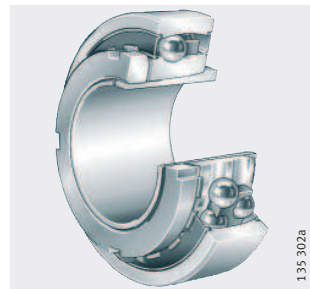

With extended inner ring

112

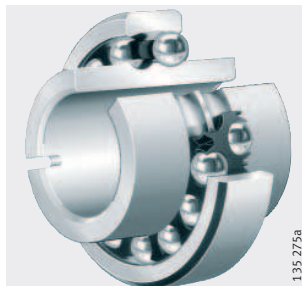

Self-aligning ball bearings

Features	Self-aligning ball bearings are double row, self-retaining units comprising outer rings with a concave raceway, inner rings with a cylindrical or tapered bore and ball and cage assemblies. The bearings are available in open and sealed designs.
Radial and axial load capacity	Self-aligning ball bearings can support axial forces in both directions as well as radial forces.
With cylindrical/tapered bore	Bearings of series 12, 13, 22 and 23 are available with a cylindrical or tapered bore. Bearings with a tapered bore have a bore taper of 1:12 and the suffix K.
With adapter sleeve	Self-aligning ball bearings with a tapered bore are also available with an adapter sleeve, locknut and tab washer. Adapter sleeves must be ordered in addition to the bearing.
With extended inner ring	Bearings of series 112 have an extended inner ring, a location slot on one side of the inner ring and are located by means of dowel pins. These bearings are intended for simple bearing arrangements with conventional shafts. Due to the bearing bore tolerance (J7), they are very easy to fit.
Sealing/lubrication	Self-aligning ball bearings of series 12, 13, 22 and 23 are also available in sealed designs. Sealed bearings have contact seals on both sides and the suffix 2RS. They are greased with a high quality grease and are maintenance-free.
Compensation of angular misalignments	Under normal operating conditions and with a rotating inner ring, self-aligning ball bearings can swivel approx. 4° about their central position; sealed bearings can swivel by max. 1,5°. As a result, they permit skewing between the inner and outer ring and can thus compensate misalignments, shaft deflections and housing deformations. If the outer ring rotates or the inner ring undergoes tumbling motion, the angular adjustment facility is smaller. In this case, please contact us.
Operating temperature	Open bearings with brass cages can be used at operating temperatures from -30 °C to +150 °C. Caution! Bearings with cages made from glass fibre reinforced polyamide are suitable for operating temperatures up to +120 °C. Sealed self-aligning ball bearings are suitable for operating temperatures from -30 °C to +100 °C, restricted by the grease and seal material.



Self-aligning ball bearings

Cages The standard cages for self-aligning ball bearings are shown in the table Cage/bore code.

Self-aligning ball bearings with cages made from glass fibre reinforced polyamide 66 have the suffix TVH.

Ball-guided solid brass cages are indicated by the suffix M.

Caution! Check the chemical resistance of polyamide to synthetic greases and oils and lubricants with EP additives.

Aged oil and additives in the oil can impair the operating life of plastic cages at high temperatures.

The oil change intervals must be observed.

Cage/bore code

Series	Solid polyamide cage ¹⁾ Bore code	Solid brass cage ¹⁾
10	8	–
12	up to 18	from 19
13	up to 13	from 14
22	up to 13, 15, 16, 18	14, 17, from 19
23	up to 13	from 14
112	04 to 12	–

¹⁾ Other cage designs available by agreement. In such cages, suitability for high speeds and temperatures as well as the basic load ratings may differ from the values for bearings with standard cages.

Suffixes

Suffixes for available designs: see table.

Available designs

Suffix	Description	Design
C3	Radial internal clearance larger than normal	Standard for tapered bore
K	Tapered bore	Standard
M	Solid brass cage	Standard
TVH	Solid cage made from glass fibre reinforced polyamide 66	Standard
2RS	Contact seals on both sides	Standard

Design and safety guidelines
Equivalent dynamic bearing load

For bearings under dynamic loading, the following applies:

Load ratio	Equivalent dynamic load
$\frac{F_a}{F_r} \leq e$	$P = F_r + Y_1 \cdot F_a$
$\frac{F_a}{F_r} > e$	$P = 0,65 \cdot F_r + Y_2 \cdot F_a$

P N
 Equivalent dynamic bearing load for combined load
 F_a N
 Axial dynamic bearing load
 F_r N
 Radial dynamic bearing load
 e, Y₁, Y₂ –
 Factors from dimension tables.



Equivalent static bearing load

For bearings under static loading, the following applies:

$$P_0 = F_{0r} + Y_0 \cdot F_{0a}$$

P₀ N
 Equivalent static bearing load for combined load
 F_{0a} N
 Axial static bearing load
 F_{0r} N
 Radial static bearing load
 Y₀ –
 Factors from dimension tables.

Minimum load

In order to ensure slippage-free operation, the bearings must be subjected to sufficient load. If insufficient load is applied – for example at high speeds during a test run – slippage can occur that may lead under conditions of inadequate lubrication to bearing damage.

The minimum load should be $P/C_r = 0,01$.

Speeds

Caution!

If the reference speed n_b in the dimension tables is higher than the limiting speed n_G , the higher value cannot be used.
 In bearings with contact seals (suffix 2RS), the speed is limited by the permissible sliding speed of the sealing lips, so only the limiting speed n_G is given in the tables.

Mounting dimensions

The dimension tables give the maximum radius dimension r_a and the diameters of the abutment shoulders.

When fitting self-aligning ball bearings with adapter sleeves, attention must be paid to the dimensions of the support ring.

Self-aligning ball bearings

Projecting balls in bearings with brass cage

In some bearings with a brass cage, the balls project to a certain extent at the sides. The projection C_1 must be taken into consideration when designing the adjacent construction.

The projection is larger in the following bearings according to the table, *Figure 1*:

Ball projection

Bearing	Projection C_1 mm
1224-M	1,8
1226-M	0,6
1228-M	2,7
1230-M	3,8
1319-M	1,6
1320-M	2,4
1321-M	2,5
1322-M	2,7

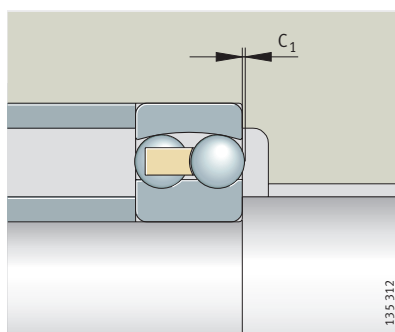

Figure 1
Ball projection C_1

Location Series 112

These bearings are axially located by means of dowel pins that engage in the slot in the inner ring, *Figure 2*. These also prevent the inner rings creeping on the shaft.

If a shaft is to be supported by two bearings, the locating slots must be arranged on the sides of the bearing facing towards or away from each other, *Figure 2*.

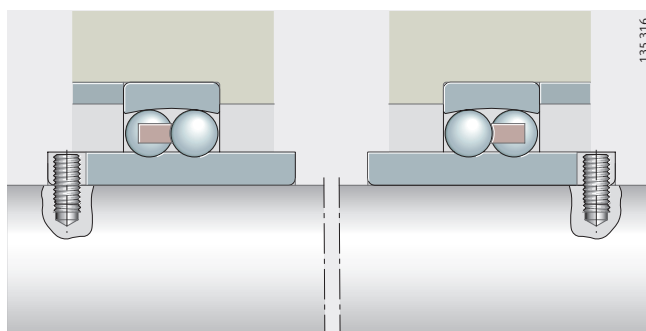

Figure 2
Location and
arrangement of bearings

Bearings with tapered bore

Bearings with a tapered inner ring bore are:

- located either directly on tapered shaft seats or
- located on a cylindrical shaft seat using an adapter sleeve, locknut and tab washer.

If high axial forces are present, a support ring can be used. For fitting, attention must be paid to the dimensions on the support ring according to the dimension tables.

Accuracy

The main dimensions of the bearings conform to DIN 630.

The dimensional and geometrical tolerances of the bearings correspond to tolerance class PN to DIN 620-2.

In series 112, the bearing bore tolerance is J7.

Radial internal clearance of bearings with cylindrical bore

The radial internal clearance is CN.



Radial internal clearance to DIN 620-4

Bore d mm		Radial internal clearance			
		CN μm		C3 μm	
over	incl.	min.	max.	min.	max.
–	6	5	15	10	20
6	10	6	17	12	25
10	14	6	19	13	26
14	18	8	21	15	28
18	24	10	23	17	30
24	30	11	24	19	35
30	40	13	29	23	40
40	50	14	31	25	44
50	65	16	36	30	50
65	80	18	40	35	60
80	100	22	48	42	70
100	120	25	56	50	83
120	140	30	68	60	100
140	160	35	80	70	120

Radial internal clearance of bearings with tapered bore

Bearings with a tapered bore have the internal clearance group C3.

Radial internal clearance to DIN 620-4

Bore d mm		Radial internal clearance			
		CN μm		C3 μm	
over	incl.	min.	max.	min.	max.
18	24	13	26	20	33
24	30	15	28	33	39
30	40	19	35	29	46
40	50	22	39	33	52
50	65	27	47	41	61
65	80	35	57	50	75
80	100	42	68	62	90
100	120	50	81	75	108
120	140	60	98	90	130
140	160	65	110	100	150

Self-aligning ball bearings

With cylindrical bore
Open or sealed

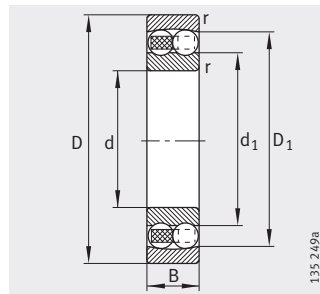

Cylindrical bore

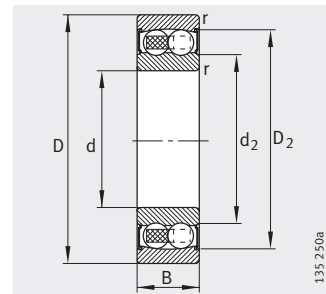

Cylindrical bore
2RS seals

Dimension table - Dimensions in mm

Designation	Mass m ≈ kg	Dimensions							
		d	D	B	r min.	D ₁ ≈	D ₂ ≈	d ₁ ≈	d ₂ ≈
135-TVH	0,01	5	19	6	0,3	14,5	–	10,1	–
126-TVH	0,009	6	19	6	0,3	14,5	–	10,1	–
127-TVH	0,014	7	22	7	0,3	16,8	–	12,4	–
108-TVH	0,014	8	22	7	0,3	16,8	–	12,4	–
129-TVH	0,022	9	26	8	0,6	20	–	14,5	–
1200-TVH	0,034	10	30	9	0,6	23,5	–	16,3	–
2200-2RS-TVH	0,053	10	30	14	0,6	–	25,9	–	14,1
2200-TVH	0,045	10	30	14	0,6	24,2	–	15,1	–
1201-TVH	0,041	12	32	10	0,6	25,4	–	18,2	–
2201-2RS-TVH	0,058	12	32	14	0,6	–	27,9	–	16,2
2201-TVH	0,05	12	32	14	0,6	26,2	–	17,1	–
1202-TVH	0,048	15	35	11	0,6	29,2	–	20,2	–
2202-2RS-TVH	0,061	15	35	14	0,6	–	31	–	19
2202-TVH	0,057	15	35	14	0,6	29,5	–	20,3	–
2302-TVH	0,111	15	42	17	1	34,8	–	22,5	–
1203-TVH	0,073	17	40	12	0,6	32,3	–	23,7	–
2203-2RS-TVH	0,098	17	40	16	0,6	–	34,3	–	21,7
2203-TVH	0,054	17	40	16	0,6	34,1	–	23,9	–
1303-TVH	0,065	17	47	14	1	37,3	–	26,7	–
2303-2RS-TVH	0,175	17	47	19	1	–	40,3	–	23,9
2303-TVH	0,155	17	47	19	1	37,3	–	26,2	–

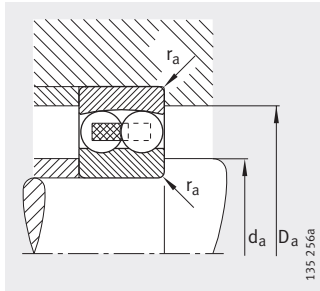

Mounting dimensions

Mounting dimensions			Basic load ratings		Calculation factors				Fatigue limit load	Limiting speed	Reference speed
d _a	D _a	r _a	dyn. C _r	stat. C _{0r}	e	Y ₁	Y ₂	Y ₀	C _{ur}	n _G	n _B
min.	max.	max.	N	N					N	min ⁻¹	min ⁻¹
7,4	16,6	0,3	2 600	475	0,35	1,82	2,82	1,91	29,5	36 000	35 000
8,4	16,6	0,3	2 600	475	0,35	1,82	2,82	1,91	29,5	36 000	39 500
9,4	19,6	0,3	2 750	560	0,33	1,92	2,97	2,01	34,5	36 000	36 500
10,6	19,4	0,3	2 750	560	0,33	1,92	2,97	2,01	34,5	36 000	–
13,2	21,8	0,6	3 950	800	0,32	1,95	3,01	2,04	50	32 000	31 500
14,2	25,8	0,6	5 700	1 180	0,32	1,95	3,02	2,05	73	30 000	28 500
14,2	25,8	0,6	5 700	1 180	0,32	1,95	3,02	2,05	73	18 000	–
14,2	25,8	0,6	8 800	1 730	0,58	1,09	1,69	1,14	107	28 000	27 500
16,2	27,8	0,6	5 700	1 260	0,37	1,69	2,62	1,77	78	30 000	27 500
16,2	27,8	0,6	5 700	1 260	0,37	1,69	2,62	1,77	78	17 000	–
16,2	27,8	0,6	9 400	1 920	0,53	1,2	1,85	1,25	120	26 000	24 600
19,2	30,8	0,6	7 700	1 730	0,34	1,86	2,88	1,95	108	26 000	24 800
19,2	30,8	0,6	7 700	1 730	0,34	1,86	2,88	1,95	108	15 000	–
19,2	30,8	0,6	9 600	2 080	0,46	1,37	2,13	1,44	130	24 000	21 100
20,6	36,4	1	17 000	3 700	0,51	1,23	1,91	1,29	232	18 000	18 200
21,2	35,8	0,6	8 100	2 000	0,33	1,93	2,99	2,03	124	22 000	22 300
21,2	35,8	0,6	8 100	2 000	0,33	1,93	2,99	2,03	124	14 000	–
21,2	35,8	0,6	11 800	2 750	0,46	1,37	2,12	1,43	171	19 000	19 600
22,6	41,4	1	12 900	3 150	0,32	1,94	3	2,03	197	18 000	17 900
22,6	41,4	1	12 900	3 150	0,32	1,94	3	2,03	197	11 000	–
22,6	41,4	1	13 900	3 150	0,53	1,19	1,85	1,25	197	17 000	16 900



Self-aligning ball bearings

With cylindrical or tapered bore
Open or sealed

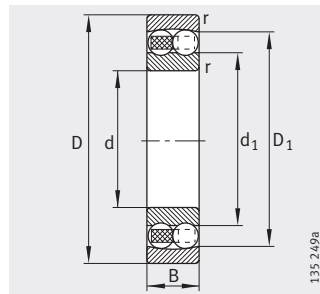

Cylindrical bore

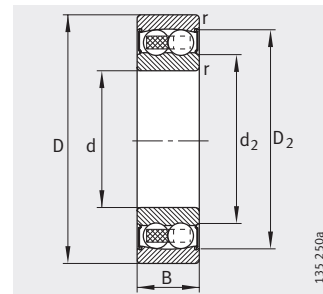

Cylindrical bore
2RS seals

Dimension table (continued) - Dimensions in mm

Designation	Mass m ≈kg	Dimensions							
		d	D	B	r min.	D ₁ ≈	D ₂ ≈	d ₁ ≈	d ₂ ≈
1204-K-TVH-C3	0,116	20	47	14	1	38,1	–	29,2	–
1204-TVH	0,118	20	47	14	1	38,1	–	29,2	–
2204-2RS-TVH	0,151	20	47	18	1	–	41,7	–	25,9
2204-TVH	0,134	20	47	18	1	39,5	–	28	–
1304-TVH	0,163	20	52	15	1,1	41,9	–	31,6	–
2304-2RS-TVH	0,23	20	52	21	1,1	–	45,2	–	27,2
2304-TVH	0,206	20	52	21	1,1	41,5	–	29,1	–
1205-K-TVH-C3	0,135	25	52	15	1	43,9	–	33,3	–
1205-TVH	0,138	25	52	15	1	43,9	–	33,3	–
2205-2RS-TVH	0,161	25	52	18	1	–	46,3	–	30,7
2205-K-2RS-TVH-C3	0,157	25	52	18	1	–	46,3	–	30,7
2205-K-TVH-C3	0,152	25	52	18	1	44,7	–	32,3	–
2205-TVH	0,156	25	52	18	1	44,7	–	32,3	–
1305-K-TVH-C3	0,254	25	62	17	1,1	50,8	–	38,1	–
1305-TVH	0,258	25	62	17	1,1	50,8	–	38,1	–
2305-2RS-TVH	0,367	25	62	24	1,1	–	53,2	–	33,5
2305-K-TVH-C3	0,328	25	62	24	1,1	50,1	–	35,5	–
2305-TVH	0,335	25	62	24	1,1	50,1	–	35,5	–
1206-K-TVH-C3	0,217	30	62	16	1	51,9	–	40,1	–
1206-TVH	0,221	30	62	16	1	51,9	–	40,1	–
2206-2RS-TVH	0,274	30	62	20	1	–	54,3	–	37,3
2206-K-2RS-TVH-C3	0,268	30	62	20	1	–	54,3	–	37,3
2206-K-TVH-C3	0,246	30	62	20	1	54	–	38,5	–
2206-TVH	0,252	30	62	20	1	54	–	38,5	–
1306-K-TVH-C3	0,379	30	72	19	1,1	59,4	–	45	–
1306-TVH	0,384	30	72	19	1,1	59,4	–	45	–
2306-2RS-TVH	0,554	30	72	27	1,1	–	63	–	40,6
2306-K-TVH-C3	0,476	30	72	27	1,1	59,3	–	41,5	–
2306-TVH	0,488	30	72	27	1,1	59,3	–	41,5	–

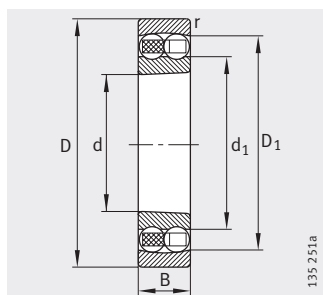

Tapered bore
K = taper 1:12

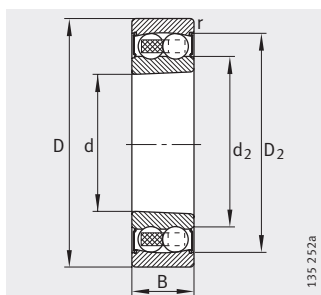

Tapered bore
K = taper 1:12
2RS seals

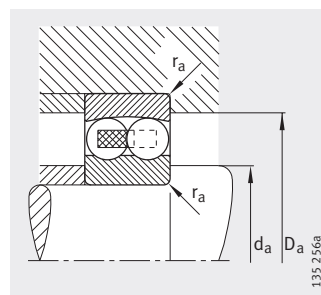

Mounting dimensions

Mounting dimensions			Basic load ratings		Calculation factors				Fatigue limit load C_{ur} N	Limiting speed n_G min^{-1}	Reference speed n_B min^{-1}
d_a min.	D_a max.	r_a max.	dyn. C_r N	stat. C_{0r} N	e	Y_1	Y_2	Y_0			
25,6	41,4	1	10 100	2 600	0,28	2,24	3,46	2,34	161	18 000	20 200
25,6	41,4	1	10 100	2 600	0,28	2,24	3,46	2,34	161	18 000	20 200
25,6	41,4	1	10 100	2 600	0,28	2,24	3,46	2,34	161	11 000	–
25,6	41,4	1	14 700	3 500	0,44	1,45	2,24	1,51	219	17 000	17 300
27	45	1	12 700	3 300	0,29	2,17	3,35	2,27	206	16 000	16 200
27	45	1	12 700	3 300	0,29	2,17	3,35	2,27	206	10 000	–
27	45	1	17 600	4 250	0,51	1,23	1,9	1,29	265	16 000	15 600
30,6	46,4	1	12 300	3 250	0,27	2,37	3,66	2,48	203	16 000	17 800
30,6	46,4	1	12 300	3 250	0,27	2,37	3,66	2,48	203	16 000	17 800
30,6	46,4	1	12 300	3 250	0,27	2,37	3,66	2,48	203	9 500	–
30,6	46,4	1	12 300	3 250	0,27	2,37	3,66	2,48	203	9 500	–
30,6	46,4	1	17 300	4 400	0,35	1,78	2,75	1,86	275	15 000	14 600
30,6	46,4	1	17 300	4 400	0,35	1,78	2,75	1,86	275	15 000	14 600
32	55	1	18 300	4 950	0,28	2,29	3,54	2,4	310	14 000	13 900
32	55	1	18 300	4 950	0,28	2,29	3,54	2,4	310	14 000	13 900
32	55	1	18 300	4 950	0,28	2,29	3,54	2,4	310	8 000	–
32	55	1	25 000	6 500	0,48	1,32	2,04	1,38	405	13 000	13 500
32	55	1	25 000	6 500	0,48	1,32	2,04	1,38	405	13 000	13 500
35,6	56,4	1	15 900	4 600	0,25	2,53	3,91	2,65	285	14 000	14 900
35,6	56,4	1	15 900	4 600	0,25	2,53	3,91	2,65	285	14 000	14 900
35,6	56,4	1	15 900	4 600	0,25	2,53	3,91	2,65	285	8 000	–
35,6	56,4	1	15 900	4 600	0,25	2,53	3,91	2,65	285	8 000	–
35,6	56,4	1	26 000	6 900	0,3	2,13	3,29	2,23	430	12 000	12 600
35,6	56,4	1	26 000	6 900	0,3	2,13	3,29	2,23	430	12 000	12 600
37	65	1	21 700	6 300	0,26	2,39	3,71	2,51	390	11 000	12 300
37	65	1	21 700	6 300	0,26	2,39	3,71	2,51	390	11 000	12 300
37	65	1	21 700	6 300	0,26	2,39	3,71	2,51	390	6 700	–
37	65	1	32 500	8 700	0,45	1,4	2,17	1,47	540	10 000	11 900
37	65	1	32 500	8 700	0,45	1,4	2,17	1,47	540	10 000	11 900



Self-aligning ball bearings

With cylindrical or tapered bore
Open or sealed

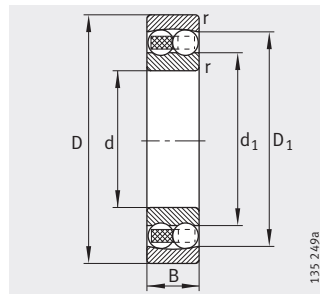

Cylindrical bore

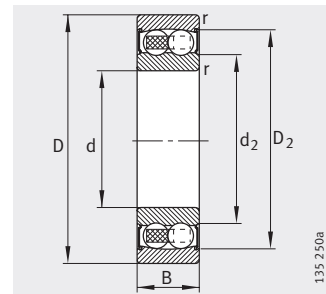

Cylindrical bore
2RS seals

Dimension table (continued) · Dimensions in mm

Designation	Mass m ≈ kg	Dimensions							
		d	D	B	r	D ₁	D ₂	d ₁	d ₂
					min.	≈	≈	≈	≈
1207-K-TVH-C3	0,319	35	72	17	1,1	59,6	–	47,7	–
1207-TVH	0,324	35	72	17	1,1	59,6	–	47,7	–
2207-2RS-TVH	0,442	35	72	23	1,1	–	64,3	–	43,5
2207-K-2RS-TVH-C3	0,432	35	72	23	1,1	–	64,3	–	43,5
2207-K-TVH-C3	0,38	35	72	23	1,1	62,9	–	45,7	–
2207-TVH	0,389	35	72	23	1,1	62,9	–	45,7	–
1307-K-TVH-C3	0,5	35	80	21	1,5	67,5	–	51,3	–
1307-TVH	0,507	35	80	21	1,5	67,5	–	51,3	–
2307-2RS-TVH	0,744	35	80	31	1,5	–	69,1	–	44,9
2307-K-TVH-C3	0,96	35	80	31	1,5	66,8	–	46,9	–
2307-TVH	0,975	35	80	31	1,5	66,8	–	46,9	–
1208-K-TVH-C3	0,408	40	80	18	1,1	67,8	–	54	–
1208-TVH	0,414	40	80	18	1,1	67,8	–	54	–
2208-2RS-TVH	0,528	40	80	23	1,1	–	71,1	–	49,2
2208-K-2RS-TVH-C3	0,517	40	80	23	1,1	–	71,1	–	49,2
2208-K-TVH-C3	0,465	40	80	23	1,1	70,7	–	52,5	–
2208-TVH	0,476	40	80	23	1,1	70,7	–	52,5	–
1308-K-TVH-C3	0,698	40	90	23	1,5	75,3	–	57,8	–
1308-TVH	0,708	40	90	23	1,5	75,3	–	57,8	–
2308-2RS-TVH	1,01	40	90	33	1,5	–	78	–	51
2308-K-TVH-C3	0,899	40	90	33	1,5	75	–	53,7	–
2308-TVH	0,922	40	90	33	1,5	75	–	53,7	–
1209-K-TVH-C3	0,454	45	85	19	1,1	72,7	–	57,7	–
1209-TVH	0,462	45	85	19	1,1	72,7	–	57,7	–
2209-2RS-TVH	0,548	45	85	23	1,1	–	75,4	–	53,8
2209-K-2RS-TVH-C3	0,535	45	85	23	1,1	–	75,4	–	53,8
2209-K-TVH-C3	0,505	45	85	23	1,1	75,9	–	59	–
2209-TVH	0,517	45	85	23	1,1	75,9	–	59	–
1309-K-TVH-C3	0,939	45	100	25	1,5	84,1	–	64,1	–
1309-TVH	0,953	45	100	25	1,5	84,1	–	64,1	–
2309-2RS-TVH	1,34	45	100	36	1,5	–	86,6	–	57,5
2309-K-TVH-C3	1,19	45	100	36	1,5	84,2	–	60,1	–
2309-TVH	1,22	45	100	36	1,5	84,2	–	60,1	–

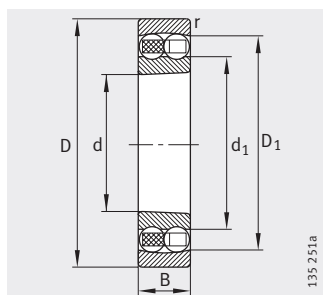

Tapered bore
K = taper 1:12

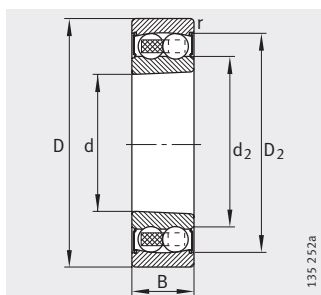

Tapered bore
K = taper 1:12
2RS seals

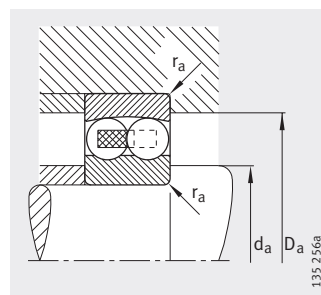

Mounting dimensions

Mounting dimensions			Basic load ratings		Calculation factors				Fatigue limit load C_{ur} N	Limiting speed n_G min^{-1}	Reference speed n_B min^{-1}
d_a min.	D_a max.	r_a max.	dyn. C_r N	stat. C_{0r} N	e	Y_1	Y_2	Y_0			
42	65	1	16 000	5 100	0,22	2,8	4,34	2,94	315	12 000	12 900
42	65	1	16 000	5 100	0,22	2,8	4,34	2,94	315	12 000	12 900
42	65	1	16 000	5 100	0,22	2,8	4,34	2,94	315	7 000	–
42	65	1	16 000	5 100	0,22	2,8	4,34	2,94	315	7 000	–
42	65	1	33 000	8 900	0,3	2,13	3,29	2,23	560	9 500	11 400
42	65	1	33 000	8 900	0,3	2,13	3,29	2,23	560	9 500	11 400
44	71	1,5	25 500	7 800	0,26	2,47	3,82	2,59	485	9 500	11 300
44	71	1,5	25 500	7 800	0,26	2,47	3,82	2,59	485	9 500	11 300
44	71	1,5	25 500	7 800	0,26	2,47	3,82	2,59	485	6 000	–
44	71	1,5	40 500	11 100	0,47	1,35	2,1	1,42	690	9 000	11 200
44	71	1,5	40 500	11 100	0,47	1,35	2,1	1,42	690	9 000	11 200
47	73	1	19 400	6 500	0,22	2,9	4,49	3,04	400	10 000	11 600
47	73	1	19 400	6 500	0,22	2,9	4,49	3,04	400	10 000	11 600
47	73	1	19 400	6 500	0,22	2,9	4,49	3,04	400	6 300	–
47	73	1	19 400	6 500	0,22	2,9	4,49	3,04	400	6 300	–
47	73	1	32 500	9 400	0,26	2,43	3,76	2,54	580	9 000	9 900
47	73	1	32 500	9 400	0,26	2,43	3,76	2,54	580	9 000	9 900
49	81	1,5	30 000	9 600	0,25	2,52	3,9	2,64	600	8 500	10 300
49	81	1,5	30 000	9 600	0,25	2,52	3,9	2,64	600	8 500	10 300
49	81	1,5	30 000	9 600	0,25	2,52	3,9	2,64	600	5 300	–
49	81	1,5	46 000	13 400	0,43	1,45	2,25	1,52	830	8 000	10 000
49	81	1,5	46 000	13 400	0,43	1,45	2,25	1,52	830	8 000	10 000
52	78	1	22 000	7 300	0,21	3,04	4,7	3,18	455	9 000	10 900
52	78	1	22 000	7 300	0,21	3,04	4,7	3,18	455	9 000	10 900
52	78	1	22 000	7 300	0,21	3,04	4,7	3,18	455	5 600	–
52	78	1	22 000	7 300	0,21	3,04	4,7	3,18	455	5 600	–
52	78	1	28 500	8 900	0,26	2,43	3,76	2,54	550	8 500	9 000
52	78	1	28 500	8 900	0,26	2,43	3,76	2,54	550	8 500	9 000
54	91	1,5	38 500	12 600	0,25	2,5	3,87	2,62	780	7 500	9 500
54	91	1,5	38 500	12 600	0,25	2,5	3,87	2,62	780	7 500	9 500
54	91	1,5	38 500	12 600	0,25	2,5	3,87	2,62	780	4 800	–
54	91	1,5	55 000	16 500	0,43	1,48	2,29	1,55	1 030	7 000	9 300
54	91	1,5	55 000	16 500	0,43	1,48	2,29	1,55	1 030	7 000	9 300



Self-aligning ball bearings

With cylindrical or tapered bore
Open or sealed

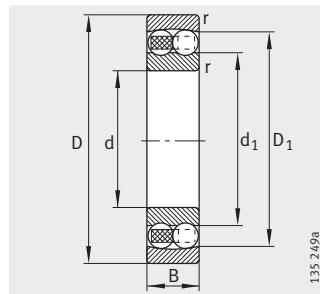

Cylindrical bore

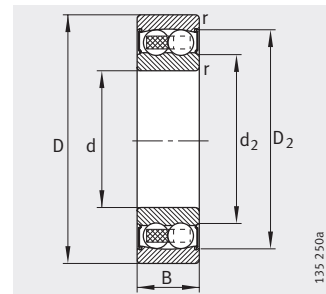

Cylindrical bore
2RS seals

Dimension table (continued) - Dimensions in mm

Designation	Mass m ≈kg	Dimensions							
		d	D	B	r	D ₁	D ₂	d ₁	d ₂
					min.	≈	≈	≈	≈
1210-K-TVH-C3	0,516	50	90	20	1,1	77,6	–	62,7	–
1210-TVH	0,526	50	90	20	1,1	77,6	–	62,7	–
2210-2RS-TVH	0,606	50	90	23	1,1	–	80	–	60,6
2210-K-2RS-TVH-C3	0,593	50	90	23	1,1	–	80	–	60,6
2210-K-TVH-C3	0,543	50	90	23	1,1	81	–	64	–
2210-TVH	0,556	50	90	23	1,1	81	–	64	–
1310-K-TVH-C3	1,52	50	110	27	2	91,9	–	71,2	–
1310-TVH	1,54	50	110	27	2	91,9	–	71,2	–
2310-2RS-TVH	1,82	50	110	40	2	–	96	–	65,9
2310-TVH	1,64	50	110	40	2	92	–	66,9	–
1211-K-TVH-C3	0,682	55	100	21	1,5	86,9	–	69,5	–
1211-TVH	0,693	55	100	21	1,5	86,9	–	69,5	–
2211-2RS-TVH	0,825	55	100	25	1,5	–	88,9	–	68
2211-K-2RS-TVH-C3	0,808	55	100	25	1,5	–	88,9	–	68
2211-K-TVH-C3	0,73	55	100	25	1,5	90	–	69,6	–
2211-TVH	0,746	55	100	25	1,5	90	–	69,6	–
1311-K-TVH-C3	1,55	55	120	29	2	101,6	–	78	–
1311-TVH	1,57	55	120	29	2	101,6	–	78	–
2311-2RS-TVH	2,28	55	120	43	2	–	107	–	70,5
2311-K-TVH-C3	2,02	55	120	43	2	100,7	–	71,7	–
2311-TVH	2,07	55	120	43	2	100,7	–	71,7	–

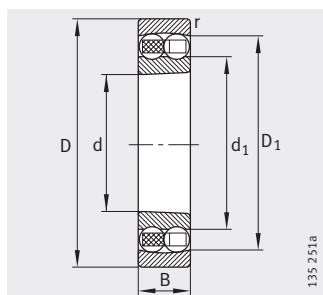

Tapered bore
K = taper 1:12

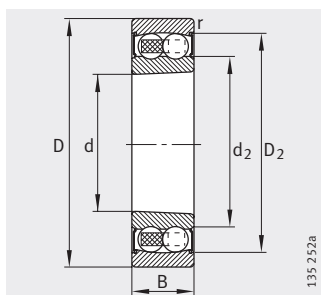

Tapered bore
K = taper 1:12
2RS seals

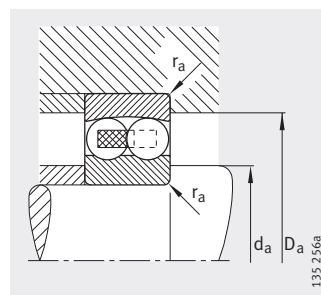

Mounting dimensions

Mounting dimensions			Basic load ratings		Calculation factors				Fatigue limit load C_{ur} N	Limiting speed n_G min^{-1}	Reference speed n_B min^{-1}
d_a min.	D_a max.	r_a max.	dyn. C_r N	stat. C_{0r} N	e	Y_1	Y_2	Y_0			
57	83	1	22 900	8 000	0,2	3,17	4,9	3,32	500	8 500	10 300
57	83	1	22 900	8 000	0,2	3,17	4,9	3,32	500	8 500	10 300
57	83	1	22 900	8 000	0,2	3,17	4,9	3,32	500	5 300	–
57	83	1	22 900	8 000	0,2	3,17	4,9	3,32	500	5 300	–
57	83	1	28 500	9 400	0,24	2,61	4,05	2,74	580	8 000	8 300
57	83	1	28 500	9 400	0,24	2,61	4,05	2,74	580	8 000	8 300
61	99	2	42 000	14 100	0,24	2,6	4,03	2,73	880	6 700	8 800
61	99	2	42 000	14 100	0,24	2,6	4,03	2,73	880	6 700	8 800
61	99	2	42 000	14 100	0,24	2,6	4,03	2,73	880	4 300	–
61	99	2	66 000	19 900	0,43	1,47	2,27	1,54	1 240	6 300	8 800
64	91	1,5	27 000	9 900	0,19	3,31	5,12	3,47	620	7 500	9 400
64	91	1,5	27 000	9 900	0,19	3,31	5,12	3,47	620	7 500	9 400
64	91	1,5	27 000	9 900	0,19	3,31	5,12	3,47	620	4 800	–
64	91	1,5	27 000	9 900	0,19	3,31	5,12	3,47	620	4 800	–
64	91	1,5	39 000	12 400	0,22	2,92	4,52	3,06	770	6 700	7 700
64	91	1,5	39 000	12 400	0,22	2,92	4,52	3,06	770	6 700	7 700
66	109	2	52 000	17 700	0,24	2,66	4,12	2,79	1 100	6 000	8 300
66	109	2	52 000	17 700	0,24	2,66	4,12	2,79	1 100	6 000	8 300
66	109	2	52 000	17 700	0,24	2,66	4,12	2,79	1 100	3 800	–
66	109	2	77 000	23 800	0,42	1,51	2,33	1,58	1 480	5 600	8 200
66	109	2	77 000	23 800	0,42	1,51	2,33	1,58	1 480	5 600	8 200



Self-aligning ball bearings

With cylindrical or tapered bore
Open or sealed

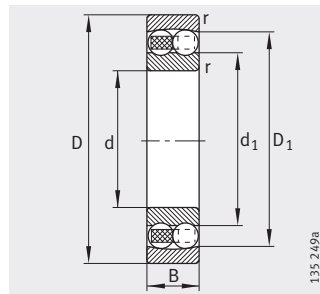

Cylindrical bore

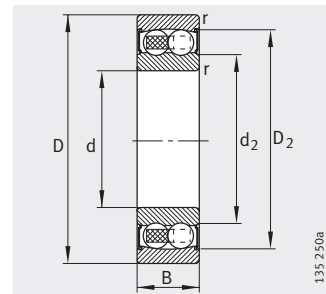

Cylindrical bore
2RS seals

Dimension table (continued) - Dimensions in mm

Designation	Mass m ≈kg	Dimensions							
		d	D	B	r	D ₁	D ₂	d ₁	d ₂
1212-K-TVH-C3	0,88	60	110	22	1,5	95,8	–	78	–
1212-TVH	0,894	60	110	22	1,5	95,8	–	78	–
2212-2RS-TVH	1,13	60	110	28	1,5	–	98,5	–	70,4
2212-K-2RS-TVH-C3	1,13	60	110	28	1,5	–	98,5	–	70,4
2212-K-TVH-C3	1,03	60	110	28	1,5	98,8	–	76,6	–
2212-TVH	1,06	60	110	28	1,5	98,8	–	76,6	–
1312-K-TVH-C3	1,94	60	130	31	2,1	112,2	–	87	–
1312-TVH	1,97	60	130	31	2,1	112,2	–	87	–
2312-K-TVH-C3	2,52	60	130	46	2,1	109,1	–	77	–
2312-TVH	2,58	60	130	46	2,1	109,1	–	77	–
1213-K-TVH-C3	1,13	65	120	23	1,5	103,2	–	85,2	–
1213-TVH	1,14	65	120	23	1,5	103,2	–	85,2	–
2213-2RS-TVH	1,53	65	120	31	1,5	–	106,6	–	78
2213-K-2RS-TVH-C3	1,5	65	120	31	1,5	–	106,6	–	78
2213-K-TVH-C3	1,33	65	120	31	1,5	107,5	–	82,4	–
2213-TVH	1,36	65	120	31	1,5	107,5	–	82,4	–
1313-K-TVH-C3	2,41	65	140	33	2,1	118,8	–	92,7	–
1313-TVH	2,44	65	140	33	2,1	118,8	–	92,7	–
2313-K-TVH-C3	3,16	65	140	48	2,1	118,9	–	85,6	–
2313-TVH	3,23	65	140	48	2,1	118,9	–	85,6	–
1214-K-TVH-C3	1,23	70	125	24	1,5	106,6	–	87,7	–
1214-TVH	1,25	70	125	24	1,5	106,6	–	87,7	–
2214-2RS-TVH	1,59	70	125	31	1,5	–	111,4	–	84,7
2214-M	1,69	70	125	31	1,5	108,9	–	87,6	–
1314-M	3,22	70	150	35	2,1	126,4	–	97,7	–
2314-M	4,38	70	150	51	2,1	127,2	–	91,5	–
1215-K-TVH-C3	1,32	75	130	25	1,5	114,1	–	93,7	–
1215-TVH	1,34	75	130	25	1,5	114,1	–	93,7	–
2215-K-TVH-C3	1,6	75	130	31	1,5	114,3	–	93,3	–
2215-TVH	1,6	75	130	31	1,5	114,3	–	93,3	–
1315-K-M-C3	3,81	75	160	37	2,1	134,8	–	104,4	–
1315-M	3,86	75	160	37	2,1	134,8	–	104,4	–
2315-K-M-C3	5,21	75	160	55	2,1	146,7	–	100,5	–
2315-M	5,33	75	160	55	2,1	146,7	–	100,5	–

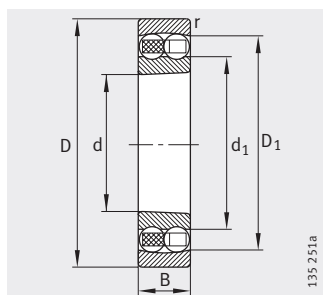

Tapered bore
K = taper 1:12

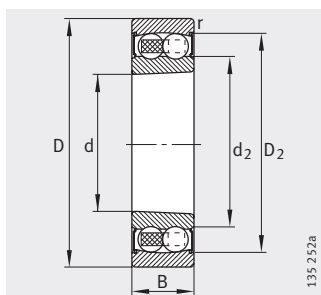

Tapered bore
K = taper 1:12
2RS seals

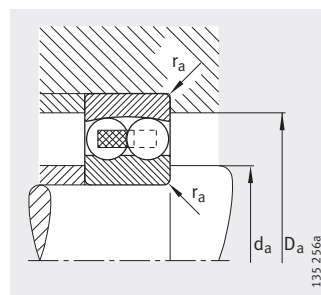

Mounting dimensions

Mounting dimensions			Basic load ratings		Calculation factors				Fatigue limit load	Limiting speed	Reference speed
d_a	D_a	r_a	dyn. C_r	stat. C_{0r}	e	Y_1	Y_2	Y_0	C_{ur}	n_G	n_B
min.	max.	max.	N	N					N	min^{-1}	min^{-1}
69	101	1,5	30 500	11 400	0,18	3,47	5,37	3,64	710	6 700	8 600
69	101	1,5	30 500	11 400	0,18	3,47	5,37	3,64	710	6 700	8 600
69	101	1,5	30 500	11 400	0,18	3,47	5,37	3,64	710	4 300	–
69	101	1,5	30 500	11 400	0,18	3,47	5,37	3,64	710	4 300	–
69	101	1,5	48 000	16 300	0,23	2,69	4,16	2,82	1 020	6 300	7 400
69	101	1,5	48 000	16 300	0,23	2,69	4,16	2,82	1 020	6 300	7 400
72	118	2,1	58 000	20 600	0,23	2,77	4,28	2,9	1 280	5 300	7 800
72	118	2,1	58 000	20 600	0,23	2,77	4,28	2,9	1 280	5 300	7 800
72	118	2,1	89 000	28 000	0,41	1,55	2,4	1,62	1 740	5 000	7 800
72	118	2,1	89 000	28 000	0,41	1,55	2,4	1,62	1 740	5 000	7 800
74	111	1,5	31 000	12 400	0,18	3,57	5,52	3,74	770	6 300	8 000
74	111	1,5	31 000	12 400	0,18	3,57	5,52	3,74	770	6 300	8 000
74	111	1,5	31 000	12 400	0,18	3,57	5,52	3,74	770	4 000	–
74	111	1,5	31 000	12 400	0,18	3,57	5,52	3,74	770	4 000	–
74	111	1,5	58 000	19 000	0,23	2,78	4,31	2,92	1 190	5 300	7 100
74	111	1,5	58 000	19 000	0,23	2,78	4,31	2,92	1 190	5 300	7 100
77	128	2,1	63 000	22 700	0,23	2,75	4,26	2,88	1 380	5 000	7 400
77	128	2,1	63 000	22 700	0,23	2,75	4,26	2,88	1 380	5 000	7 400
77	128	2,1	98 000	32 000	0,39	1,62	2,51	1,7	1 980	4 800	7 300
77	128	2,1	98 000	32 000	0,39	1,62	2,51	1,7	1 980	4 800	7 300
79	116	1,5	35 000	13 700	0,19	3,36	5,21	3,52	850	6 000	7 700
79	116	1,5	35 000	13 700	0,19	3,36	5,21	3,52	850	6 000	7 700
79	116	1,5	35 000	13 700	0,19	3,36	5,21	3,52	850	3 800	–
79	116	1,5	44 000	16 900	0,27	2,34	3,62	2,45	1 050	8 500	6 600
82	138	2,1	75 000	27 500	0,23	2,79	4,32	2,93	1 620	7 000	7 000
82	138	2,1	112 000	37 000	0,38	1,65	2,55	1,73	2 210	6 300	6 900
84	121	1,5	39 000	15 500	0,19	3,32	5,15	3,48	950	5 600	7 500
84	121	1,5	39 000	15 500	0,19	3,32	5,15	3,48	950	5 600	7 500
84	121	1,5	44 500	17 600	0,26	2,47	3,82	2,59	1 080	5 300	6 300
84	121	1,5	44 500	17 600	0,26	2,47	3,82	2,59	1 080	5 300	6 300
87	148	2,1	80 000	29 500	0,23	2,77	4,29	2,9	1 690	6 300	6 700
87	148	2,1	80 000	29 500	0,23	2,77	4,29	2,9	1 690	6 300	6 700
87	148	2,1	124 000	42 000	0,38	1,64	2,54	1,72	2 420	6 000	6 700
87	148	2,1	124 000	42 000	0,38	1,64	2,54	1,72	2 420	6 000	6 700



Self-aligning ball bearings

With cylindrical or tapered bore

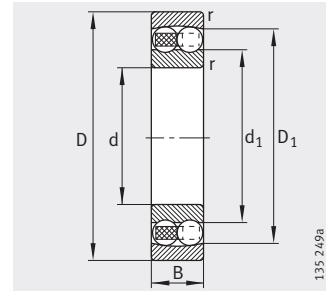

Cylindrical bore

Dimension table (continued) - Dimensions in mm

Designation	Mass m ≈kg	Dimensions					
		d	D	B	r min.	D ₁ ≈	d ₁ ≈
1216-K-TVH-C3	1,62	80	140	26	2	122,1	102
1216-TVH	1,65	80	140	26	2	122,1	102
2216-K-TVH-C3	1,97	80	140	33	2	120,8	99,5
2216-TVH	2,01	80	140	33	2	120,8	99,5
1316-K-M-C3	4,5	80	170	39	2,1	144,3	110,2
1316-M	4,56	80	170	39	2,1	144,3	110,2
2316-K-M-C3	6,18	80	170	58	2,1	144,5	107,6
2316-M	6,31	80	170	58	2,1	144,5	107,6
1217-K-TVH-C3	2,03	85	150	28	2	130,4	107,5
1217-TVH	2,07	85	150	28	2	130,4	107,5
2217-K-M-C3	2,73	85	150	36	2	130	105,2
2217-M	2,79	85	150	36	2	130	105,2
1317-K-M-C3	5,32	85	180	41	3	152	117,2
1317-M	5,39	85	180	41	3	152	117,2
2317-K-M-C3	7,36	85	180	60	3	153,3	114
2317-M	7,35	85	180	60	3	153,3	114
1218-K-TVH-C3	2,48	90	160	30	2	138,7	112,7
1218-TVH	2,52	90	160	30	2	138,7	112,7
2218-K-TVH-C3	3,18	90	160	40	2	139,4	111,5
2218-TVH	3,18	90	160	40	2	139,4	111,5
1318-K-M-C3	6,27	90	190	43	3	159,9	124,4
1318-M	6,35	90	190	43	3	159,9	124,4
2318-K-M-C3	8,6	90	190	64	3	161	115,7
2318-M	8,78	90	190	64	3	161	115,7
1219-K-M-C3	3,28	95	170	32	2,1	148,2	120,5
1219-M	3,32	95	170	32	2,1	148,2	120,5
2219-K-M-C3	4,24	95	170	43	2,1	148,6	118,9
2219-M	4,33	95	170	43	2,1	148,6	118,9
1319-K-M-C3	7,2	95	200	45	3	170,5	127,7
1319-M	7,29	95	200	45	3	170,5	127,6
2319-K-M-C3	9,97	95	200	67	3	168,5	121,6
2319-M	10,2	95	200	67	3	168,5	121,6

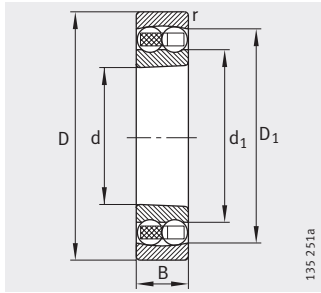

Tapered bore
K = taper 1:12

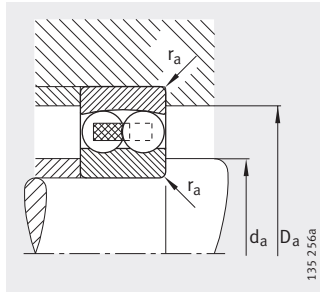

Mounting dimensions

Mounting dimensions			Basic load ratings		Calculation factors				Fatigue limit load	Limiting speed	Reference speed
da	Da	ra	dyn. Cr	stat. Cor	e	Y1	Y2	Y0	Cur	nG	nB
min.	max.	max.	N	N					N	min ⁻¹	min ⁻¹
91	129	2	40 000	16 800	0,16	3,9	6,03	4,08	990	5 000	7 000
91	129	2	40 000	16 800	0,16	3,9	6,03	4,08	990	5 000	7 000
91	129	2	49 500	19 800	0,25	2,48	3,84	2,6	1 180	5 000	6 000
91	129	2	49 500	19 800	0,25	2,48	3,84	2,6	1 180	5 000	6 000
92	158	2,1	89 000	33 000	0,22	2,87	4,44	3	1 810	6 000	6 400
92	158	2,1	89 000	33 000	0,22	2,87	4,44	3	1 810	6 000	6 400
92	158	2,1	139 000	48 500	0,37	1,7	2,62	1,78	2 700	5 600	6 400
92	158	2,1	139 000	48 500	0,37	1,7	2,62	1,78	2 700	5 600	6 400
96	139	2	49 500	20 600	0,17	3,73	5,78	3,91	1 180	4 800	6 800
96	139	2	49 500	20 600	0,17	3,73	5,78	3,91	1 180	4 800	6 800
96	139	2	59 000	23 400	0,26	2,46	3,81	2,58	1 340	7 000	5 800
96	139	2	59 000	23 400	0,26	2,46	3,81	2,58	1 340	7 000	5 800
99	166	2,5	99 000	37 500	0,22	2,88	4,46	3,02	2 010	5 600	6 200
99	166	2,5	99 000	37 500	0,22	2,88	4,46	3,02	2 010	5 600	6 200
99	166	2,5	143 000	51 000	0,37	1,68	2,61	1,76	2 750	5 300	6 100
99	166	2,5	143 000	51 000	0,37	1,68	2,61	1,76	2 750	5 300	6 100
101	149	2	57 000	23 300	0,17	3,74	5,79	3,92	1 300	4 500	6 500
101	149	2	57 000	23 300	0,17	3,74	5,79	3,92	1 300	4 500	6 500
101	149	2	71 000	28 500	0,27	2,33	3,61	2,44	1 580	4 300	5 700
101	149	2	71 000	28 500	0,27	2,33	3,61	2,44	1 580	4 300	5 700
104	176	2,5	109 000	42 500	0,22	2,83	4,38	2,97	2 230	5 300	5 900
104	176	2,5	109 000	42 500	0,22	2,83	4,38	2,97	2 230	5 300	5 900
104	176	2,5	156 000	57 000	0,39	1,63	2,53	1,71	3 000	5 000	5 800
104	176	2,5	156 000	57 000	0,39	1,63	2,53	1,71	3 000	5 000	5 800
107	158	2,1	64 000	27 000	0,17	3,73	5,78	3,91	1 450	6 000	6 300
107	158	2,1	64 000	27 000	0,17	3,73	5,78	3,91	1 450	6 000	6 300
107	158	2,1	84 000	34 000	0,27	2,32	3,59	2,43	1 840	6 000	5 600
107	158	2,1	84 000	34 000	0,27	2,32	3,59	2,43	1 840	6 000	5 600
109	186	2,5	134 000	50 000	0,23	2,73	4,23	2,86	2 550	5 000	5 700
109	186	2,5	134 000	50 000	0,23	2,73	4,23	2,86	2 550	5 000	5 700
109	186	2,5	167 000	63 000	0,38	1,66	2,57	1,74	3 250	4 800	5 500
109	186	2,5	167 000	63 000	0,38	1,66	2,57	1,74	3 250	4 800	5 500



Self-aligning ball bearings

With cylindrical or tapered bore

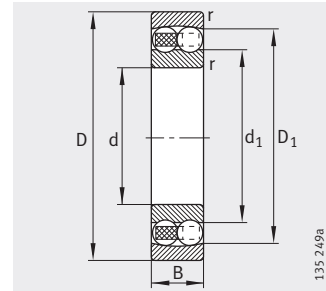

Cylindrical bore

Dimension table (continued) · Dimensions in mm

Designation	Mass m ≈ kg	Dimensions					
		d	D	B	r min.	D ₁ ≈	d ₁ ≈
1220-K-M-C3	3,94	100	180	34	2,1	155,2	127,7
1220-M	3,99	100	180	34	2,1	155,2	127,7
2220-K-M-C3	5,1	100	180	46	2,1	156,9	124,4
2220-M	5,21	100	180	46	2,1	156,9	124,4
1320-K-M-C3	8,95	100	215	47	3	182,6	135,5
1320-M	9,06	100	215	47	3	182,6	135,5
2320-K-M-C3	12,7	100	215	73	3	183	130,8
2320-M	12,9	100	215	73	3	183	130,8
1221-M	4,75	105	190	36	2,1	164,4	133,9
1321-M	10,3	105	225	49	3	191,3	143,2
1222-K-M-C3	5,49	110	200	38	2,1	173,9	140,7
1222-M	5,57	110	200	38	2,1	173,9	140,7
2222-K-M-C3	7,27	110	200	53	2,1	174,1	136,9
2222-M	7,45	110	200	53	2,1	174,1	136,9
1322-K-M-C3	12,2	110	240	50	3	203,2	154,7
1322-M	12,3	110	240	50	3	203,2	154,5
2322-K-M-C3	17,5	110	240	80	3	203	145,5
2322-M	18,1	110	240	80	3	203	145,5
1224-M	7,13	120	215	42	2,1	187,3	149
1226-M	8,67	130	230	46	3	200,1	161,5
1228-M	11,2	140	250	50	3	221,2	175
1230-M	14,6	150	270	54	3	237,9	186,7

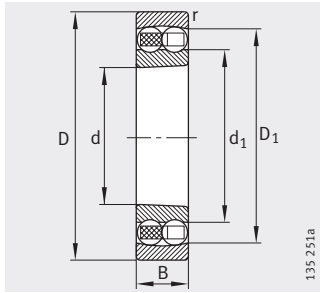

Tapered bore
K = taper 1:12

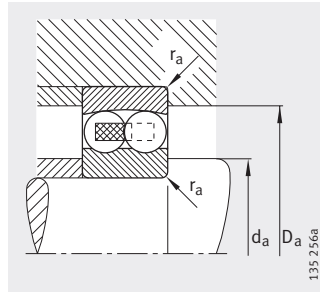

Mounting dimensions

Mounting dimensions			Basic load ratings		Calculation factors				Fatigue limit load	Limiting speed	Reference speed
d _a	D _a	r _a	dyn. C _r	stat. C _{0r}	e	Y ₁	Y ₂	Y ₀	C _{ur}	n _G	n _B
min.	max.	max.	N	N					N	min ⁻¹	min ⁻¹
112	168	2,1	70 000	29 500	0,18	3,58	5,53	3,75	1 550	5 600	6 200
112	168	2,1	70 000	29 500	0,18	3,58	5,53	3,75	1 550	5 600	6 200
112	168	2,1	98 000	40 000	0,27	2,33	3,61	2,44	2 120	5 600	5 600
112	168	2,1	98 000	40 000	0,27	2,33	3,61	2,44	2 120	5 600	5 600
114	201	2,5	145 000	57 000	0,24	2,68	4,15	2,81	2 800	4 800	5 400
114	201	2,5	145 000	57 000	0,24	2,68	4,15	2,81	2 800	4 800	5 400
114	201	2,5	196 000	78 000	0,38	1,67	2,58	1,75	3 900	4 500	5 200
114	201	2,5	196 000	78 000	0,38	1,67	2,58	1,75	3 900	4 500	5 200
117	178	2,1	75 000	32 000	0,18	3,54	5,48	3,71	1 640	5 300	6 600
119	211	2,5	158 000	64 000	0,23	2,75	4,25	2,88	3 100	4 500	5 200
122	188	2,1	89 000	38 000	0,17	3,61	5,59	3,78	1 900	5 000	5 800
122	188	2,1	89 000	38 000	0,17	3,61	5,59	3,78	1 900	5 000	5 800
122	188	2,1	126 000	51 000	0,28	2,23	3,45	2,33	2 550	5 000	5 300
122	188	2,1	126 000	51 000	0,28	2,23	3,45	2,33	2 550	5 000	5 300
124	226	2,5	165 000	71 000	0,23	2,79	4,32	2,92	3 300	4 500	4 850
124	226	2,5	165 000	71 000	0,23	2,79	4,32	2,92	3 300	4 500	4 850
124	226	2,5	221 000	94 000	0,37	1,69	2,62	1,77	4 400	4 300	4 600
124	226	2,5	221 000	94 000	0,37	1,69	2,62	1,77	4 400	4 300	4 600
132	203	2,1	121 000	52 000	0,2	3,11	4,81	3,25	2 500	4 800	5 600
144	216	2,5	125 000	55 000	0,19	3,24	5,02	3,4	2 550	4 500	5 400
154	236	2,5	163 000	74 000	0,21	3,05	4,71	3,19	3 600	4 300	4 950
164	256	2,5	180 000	86 000	0,22	2,9	4,49	3,04	3 700	3 800	4 600



Self-aligning ball bearings

With extended inner ring

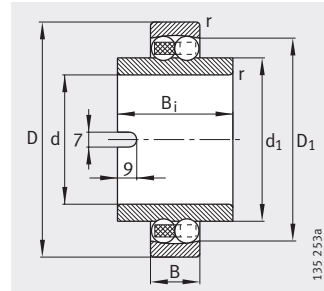

Extended inner ring

Dimension table · Dimensions in mm

Designation	Mass m ≈ kg	Dimensions							Mounting dimensions	
		d	D	B	r min.	B _i	D ₁ ≈	d ₁ ≈	D _a max.	r _a max.
11204-TVH	0,085	20	47	14	1	40	38,1	29,2	41,4	1
11205-TVH	0,226	25	52	15	1	44	43,9	33,3	46,4	1
11206-TVH	0,364	30	62	16	1	48	51,9	40,1	56,4	1
11207-TVH	0,554	35	72	17	1,1	52	59,6	47,7	65	1
11208-TVH	0,722	40	80	18	1,1	56	67,8	54	73	1
11209-TVH	0,78	45	85	19	1,1	58	72,7	57,7	78	1
11210-TVH	0,866	50	90	20	1,1	58	77,6	62,7	83	1
11211-TVH	1,13	55	100	21	1,5	60	86,9	69,5	91	1,5
11212-TVH	1,51	60	110	22	1,5	62	95,8	78	101	1,5

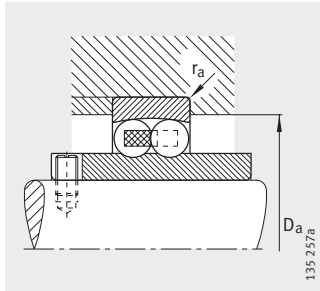

Mounting dimensions

Basic load ratings		Calculation factors				Fatigue limit load	Limiting speed
dyn. C_r N	stat. C_{0r} N	e	Y_1	Y_2	Y_0	C_{ur} N	n_G min^{-1}
10 100	2 600	0,28	2,24	3,46	2,34	161	13 000
12 300	3 250	0,27	2,37	3,66	2,48	203	10 000
15 900	4 600	0,25	2,53	3,91	2,65	285	8 500
16 000	5 100	0,22	2,8	4,34	2,94	315	7 500
19 400	6 500	0,22	2,9	4,49	3,04	400	6 700
22 000	7 300	0,21	3,04	4,7	3,18	455	6 000
22 900	8 000	0,2	3,17	4,9	3,32	500	5 600
27 000	9 900	0,19	3,31	5,12	3,47	620	5 000
30 500	11 400	0,18	3,47	5,37	3,64	710	4 500



Self-aligning ball bearings

With adapter sleeve
Open or sealed

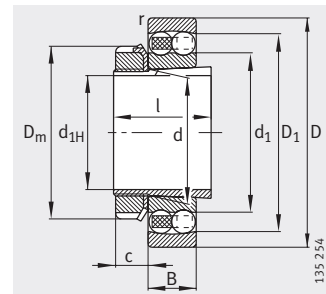

Open

Dimension table · Dimensions in mm

Designation		Mass m		Dimensions									
Bearing	Adapter sleeve	Bearing ≈kg	Adapter sleeve ≈kg	d _{1H}	d	D	B	r	D ₁	D ₂	d ₁	d ₂	D _m
								min.	≈	≈	≈	≈	
1204-K-TVH-C3	H204	0,116	0,041	17	20	47	14	1	38,1	–	29,2	–	32
1205-K-TVH-C3	H205	0,135	0,069	20	25	52	15	1	43,9	–	33,3	–	38
2205-K-2RS-TVH-C3	H305	0,157	0,075	20	25	52	18	1	–	46,3	–	30,7	38
2205-K-TVH-C3	H305	0,152	0,075	20	25	52	18	1	44,7	–	32,3	–	38
1305-K-TVH-C3	H305	0,254	0,075	20	25	62	17	1,1	50,8	–	38,1	–	38
2305-K-TVH-C3	H2305	0,328	0,085	20	25	62	24	1,1	50,1	–	35,5	–	38
1206-K-TVH-C3	H206	0,217	0,091	25	30	62	16	1	51,9	–	40,1	–	45
2206-K-2RS-TVH-C3	H306	0,268	0,099	25	30	62	20	1	–	54,3	–	37,3	45
2206-K-TVH-C3	H306	0,246	0,099	25	30	62	20	1	54	–	38,5	–	45
1306-K-TVH-C3	H306	0,379	0,099	25	30	72	19	1,1	59,4	–	45	–	45
2306-K-TVH-C3	H2306	0,476	0,116	25	30	72	27	1,1	59,3	–	41,5	–	45
1207-K-TVH-C3	H207	0,319	0,129	30	35	72	17	1,1	59,6	–	47,7	–	57
2207-K-2RS-TVH-C3	H307	0,432	0,147	30	35	72	23	1,1	–	64,3	–	43,5	57
2207-K-TVH-C3	H307	0,38	0,147	30	35	72	23	1,1	62,9	–	45,7	–	57
1307-K-TVH-C3	H307	0,5	0,147	30	35	80	21	1,5	67,5	–	51,3	–	57
2307-K-TVH-C3	H2307	0,96	0,171	30	35	80	31	1,5	66,8	–	46,9	–	52
1208-K-TVH-C3	H208	0,408	0,17	35	40	80	18	1,1	67,8	–	54	–	58
2208-K-2RS-TVH-C3	H308	0,517	0,185	35	40	80	23	1,1	–	71,1	–	49,2	58
2208-K-TVH-C3	H308	0,465	0,185	35	40	80	23	1,1	70,7	–	52,5	–	58
1308-K-TVH-C3	H308	0,698	0,185	35	40	90	23	1,5	75,3	–	57,8	–	58
2308-K-TVH-C3	H2308	0,899	0,222	35	40	90	33	1,5	75	–	53,7	–	58
1209-K-TVH-C3	H209	0,454	0,216	40	45	85	19	1,1	72,7	–	57,7	–	65
2209-K-2RS-TVH-C3	H309	0,535	0,246	40	45	85	23	1,1	–	75,4	–	53,8	65
2209-K-TVH-C3	H309	0,505	0,246	40	45	85	23	1,1	75,9	–	59	–	65
1309-K-TVH-C3	H309	0,939	0,246	40	45	100	25	1,5	84,1	–	64,1	–	65
2309-K-TVH-C3	H2309	1,19	0,283	40	45	100	36	1,5	84,2	–	60,1	–	65

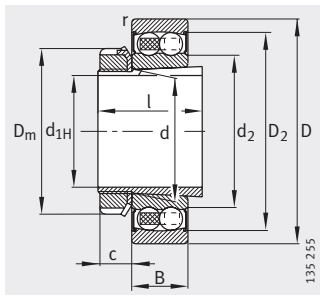

2RS seals

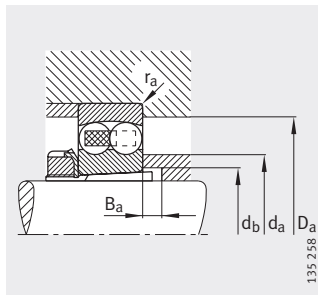

Mounting dimensions

		Mounting dimensions					Basic load ratings		Calculation factors				Fatigue limit load	Limiting speed	Reference speed
l	c	da	Da	db	Ba	ra	dyn. Cr N	stat. Cor N	e	Y1	Y2	Y0	C _{ur} N	n _G min ⁻¹	n _B min ⁻¹
	≈	max.	max.	min.	min.	max.									
24	7	27	41,4	23	5	1	10 100	2 600	0,28	2,24	3,46	2,34	161	18 000	20 200
26	9	32	46,4	28	5	1	12 300	3 250	0,27	2,37	3,66	2,48	203	16 000	17 800
29	9	32	46,4	28	5	1	12 300	3 250	0,27	2,37	3,66	2,48	203	9 500	–
29	9	32	46,4	28	5	1	17 300	4 400	0,35	1,78	2,75	1,86	275	15 000	14 600
29	9	35	55	28	6	1	18 300	4 950	0,28	2,29	3,54	2,4	310	14 000	13 900
35	9	34	55	30	5	1	25 000	6 500	0,48	1,32	2,04	1,38	405	13 000	13 500
27	9	38	56,4	33	5	1	15 900	4 600	0,25	2,53	3,91	2,65	285	14 000	14 900
31	9	38	56,4	33	5	1	15 900	4 600	0,25	2,53	3,91	2,65	285	8 000	–
31	9	38	56,4	33	5	1	26 000	6 900	0,3	2,13	3,29	2,23	430	12 000	12 600
31	9	42	65	33	6	1	21 700	6 300	0,26	2,39	3,71	2,51	390	11 000	12 300
38	9	40	65	35	5	1	32 500	8 700	0,45	1,4	2,17	1,47	540	10 000	11 900
29	10	45	65	38	5	1	16 000	5 100	0,22	2,8	4,34	2,94	315	12 000	12 900
35	10	45	65	38	5	1	16 000	5 100	0,22	2,8	4,34	2,94	315	7 000	–
35	10	44	65	39	5	1	33 000	8 900	0,3	2,13	3,29	2,23	560	9 500	11 400
35	10	49	71	39	8	1,5	25 500	7 800	0,26	2,47	3,82	2,59	485	9 500	11 300
43	10	45	71	40	5	1,5	40 500	11 100	0,47	1,35	2,1	1,42	690	9 000	11 200
31	11	52	73	43	5	1	19 400	6 500	0,22	2,9	4,49	3,04	400	10 000	11 600
36	11	52	73	43	5	1	19 400	6 500	0,22	2,9	4,49	3,04	400	6 300	–
36	11	50	73	44	5	1	32 500	9 400	0,26	2,43	3,76	2,54	580	9 000	9 900
36	11	55	81	44	5	1,5	30 000	9 600	0,25	2,52	3,9	2,64	600	8 500	10 300
46	11	51	81	45	5	1,5	46 000	13 400	0,43	1,45	2,25	1,52	830	8 000	10 000
33	12	57	78	48	5	1	22 000	7 300	0,21	3,04	4,7	3,18	455	9 000	10 900
39	12	57	78	48	5	1	22 000	7 300	0,21	3,04	4,7	3,18	455	5 600	–
39	12	56	78	50	8	1	28 500	8 900	0,26	2,43	3,76	2,54	550	8 500	9 000
39	12	61	91	50	5	1,5	38 500	12 600	0,25	2,5	3,87	2,62	780	7 500	9 500
50	12	57	91	50	5	1,5	55 000	16 500	0,43	1,48	2,29	1,55	1 030	7 000	9 300



Self-aligning ball bearings

With adapter sleeve
Open or sealed

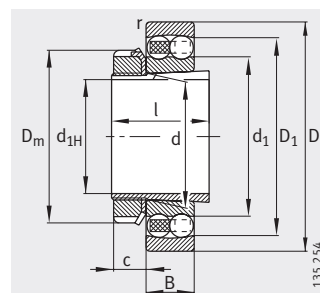

Open

Dimension table (continued) - Dimensions in mm

Designation		Mass m		Dimensions									
Bearing	Adapter sleeve	Bearing ≈kg	Adapter sleeve ≈kg	d _{1H}	d	D	B	r min.	D ₁ ≈	D ₂ ≈	d ₁ ≈	d ₂ ≈	D _m
1210-K-TVH-C3	H210	0,516	0,264	45	50	90	20	1,1	77,6	-	62,7	-	70
2210-K-2RS-TVH-C3	H310	0,593	0,301	45	50	90	23	1,1	-	80	-	60,6	70
2210-K-TVH-C3	H310	0,543	0,301	45	50	90	23	1,1	81	-	64	-	70
1310-K-TVH-C3	H310	1,52	0,301	45	50	110	27	2	91,9	-	71,2	-	70
1211-K-TVH-C3	H211	0,682	0,292	50	55	100	21	1,5	86,9	-	69,5	-	75
2211-K-2RS-TVH-C3	H311	0,808	0,35	50	55	100	25	1,5	-	88,9	-	68	75
2211-K-TVH-C3	H311	0,73	0,35	50	55	100	25	1,5	90	-	69,6	-	75
1311-K-TVH-C3	H311	1,55	0,35	50	55	120	29	2	101,6	-	78	-	75
2311-K-TVH-C3	H2311	2,02	0,426	50	55	120	43	2	100,7	-	71,7	-	75
1212-K-TVH-C3	H212	0,88	0,325	55	60	110	22	1,5	95,8	-	78	-	80
2212-K-2RS-TVH-C3	H312	1,13	0,373	55	60	110	28	1,5	-	98,5	-	70,4	80
2212-K-TVH-C3	H312	1,03	0,373	55	60	110	28	1,5	98,8	-	76,6	-	80
1312-K-TVH-C3	H312	1,94	0,373	55	60	130	31	2,1	112,2	-	87	-	80
2312-K-TVH-C3	H2312	2,52	0,464	55	60	130	46	2,1	109,1	-	77	-	80
1213-K-TVH-C3	H213	1,13	0,393	60	65	120	23	1,5	103,2	-	85,2	-	92
2213-K-2RS-TVH-C3	H313	1,5	0,452	60	65	120	31	1,5	-	106,6	-	78	92
2213-K-TVH-C3	H313	1,33	0,452	60	65	120	31	1,5	107,5	-	82,4	-	92
1313-K-TVH-C3	H313	2,41	0,452	60	65	140	33	2,1	118,8	-	92,7	-	92
2313-K-TVH-C3	H2313	3,16	0,553	60	65	140	48	2,1	118,9	-	85,6	-	92
1214-K-TVH-C3	H214	1,23	0,603	60	70	125	24	1,5	106,6	-	87,7	-	98
1215-K-TVH-C3	H215	1,32	0,693	65	75	130	25	1,5	114,1	-	93,7	-	98
2215-K-TVH-C3	H315	1,6	0,826	65	75	130	31	1,5	114,3	-	93,3	-	104
1315-K-M-C3	H315	3,81	0,826	65	75	160	37	2,1	134,8	-	104,4	-	104
2315-K-M-C3	H2315	5,21	1,05	65	75	160	55	2,1	146,7	-	100,5	-	98
1216-K-TVH-C3	H216	1,62	0,876	70	80	140	26	2	122,1	-	102	-	105
2216-K-TVH-C3	H316	1,97	1,01	70	80	140	33	2	120,8	-	99,5	-	105
1316-K-M-C3	H316	4,5	1,01	70	80	170	39	2,1	144,3	-	110,2	-	105
2316-K-M-C3	H2316	6,18	1,27	70	80	170	58	2,1	144,5	-	107,6	-	105
1217-K-TVH-C3	H217	2,03	0,995	75	85	150	28	2	130,4	-	107,5	-	110
2217-K-M-C3	H317	2,73	1,16	75	85	150	36	2	130	-	105,2	-	110
1317-K-M-C3	H317	5,32	1,16	75	85	180	41	3	152	-	117,2	-	110
2317-K-M-C3	H2317	7,36	1,44	75	85	180	60	3	153,3	-	114	-	110

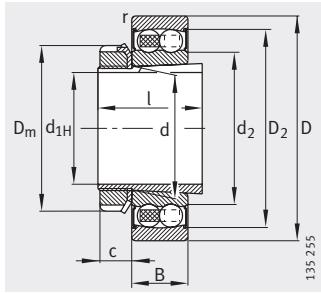

2RS seals

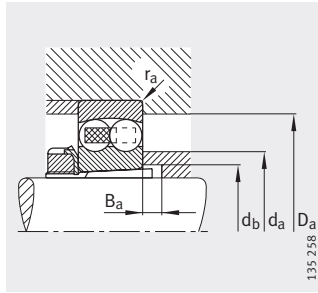

Mounting dimensions

		Mounting dimensions					Basic load ratings		Calculation factors				Fatigue limit load	Limiting speed	Reference speed
l	c	da	Da	db	Ba	ra	dyn. Cr N	stat. Cor N	e	Y1	Y2	Y0	C _{ur} N	n _G min ⁻¹	n _B min ⁻¹
	≈	max.	max.	min.	min.	max.									
35	13	62	83	53	5	1	22 900	8 000	0,2	3,17	4,9	3,32	500	8 500	10 300
42	13	62	83	53	5	1	22 900	8 000	0,2	3,17	4,9	3,32	500	5 300	—
42	13	61	83	55	10	1	28 500	9 400	0,24	2,61	4,05	2,74	580	8 000	8 300
42	13	68	99	55	5	2	42 000	14 100	0,24	2,6	4,03	2,73	880	6 700	8 800
37	13	69	91	60	6	1,5	27 000	9 900	0,19	3,31	5,12	3,47	620	7 500	9 400
45	13	69	91	60	6	1,5	27 000	9 900	0,19	3,31	5,12	3,47	620	4 800	—
45	13	68	91	60	10	1,5	39 000	12 400	0,22	2,92	4,52	3,06	770	6 700	7 700
45	13	74	109	60	6	2	52 000	17 700	0,24	2,66	4,12	2,79	1 100	6 000	8 300
59	13	69	109	61	6	2	77 000	23 800	0,42	1,51	2,33	1,58	1 480	5 600	8 200
38	13	75	101	64	5	1,5	30 500	11 400	0,18	3,47	5,37	3,64	710	6 700	8 600
47	13	75	101	64	5	1,5	30 500	11 400	0,18	3,47	5,37	3,64	710	4 300	—
47	13	73	101	65	8	1,5	48 000	16 300	0,23	2,69	4,16	2,82	1 020	6 300	7 400
47	13	83	118	65	5	2,1	58 000	20 600	0,23	2,77	4,28	2,9	1 280	5 300	7 800
62	13	74	118	66	5	2,1	89 000	28 000	0,41	1,55	2,4	1,62	1 740	5 000	7 800
40	14	83	111	70	5	1,5	31 000	12 400	0,18	3,57	5,52	3,74	770	6 300	8 000
50	14	83	111	70	5	1,5	31 000	12 400	0,18	3,57	5,52	3,74	770	4 000	—
50	14	79	111	70	8	1,5	58 000	19 000	0,23	2,78	4,31	2,92	1 190	5 300	7 100
50	14	89	128	70	5	2,1	63 000	22 700	0,23	2,75	4,26	2,88	1 380	5 000	7 400
65	14	82	128	72	5	2,1	98 000	32 000	0,39	1,62	2,51	1,7	1 980	4 800	7 300
41	14	86	116	75	5	1,5	35 000	13 700	0,19	3,36	5,21	3,52	850	6 000	7 700
43	15	92	121	80	5	1,5	39 000	15 500	0,19	3,32	5,15	3,48	950	5 600	7 500
55	15	90	121	80	12	1,5	44 500	17 600	0,26	2,47	3,82	2,59	1 080	5 300	6 300
55	15	100	148	80	5	2,1	80 000	29 500	0,23	2,77	4,29	2,9	1 690	6 300	6 700
73	15	94	148	82	5	2,1	124 000	42 000	0,38	1,64	2,54	1,72	2 420	6 000	6 700
46	17	99	129	85	5	2	40 000	16 800	0,16	3,9	6,03	4,08	990	5 000	7 000
59	17	96	129	85	12	2	49 500	19 800	0,25	2,48	3,84	2,6	1 180	5 000	6 000
59	17	107	158	85	5	2,1	89 000	33 000	0,22	2,87	4,44	3	1 810	6 000	6 400
78	17	100	158	88	5	2,1	139 000	48 500	0,37	1,7	2,62	1,78	2 700	5 600	6 400
50	18	105	139	90	6	2	49 500	20 600	0,17	3,73	5,78	3,91	1 180	4 800	6 800
63	18	102	139	91	12	2	59 000	23 400	0,26	2,46	3,81	2,58	1 340	7 000	5 800
63	18	114	166	91	6	2,5	99 000	37 500	0,22	2,88	4,46	3,02	2 010	5 600	6 200
82	18	106	166	94	6	2,5	143 000	51 000	0,37	1,68	2,61	1,76	2 750	5 300	6 100



Self-aligning ball bearings

With adapter sleeve

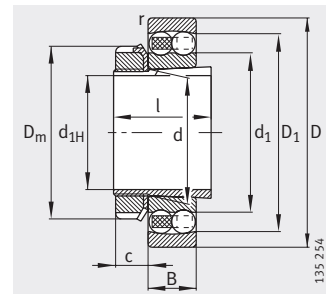

Open

Dimension table (continued) - Dimensions in mm

Designation		Mass m		Dimensions							
Bearing	Adapter sleeve	Bearing ≈kg	Adapter sleeve ≈kg	d _{1H}	d	D	B	r min.	D ₁ ≈	d ₁ ≈	D _m
1218-K-TVH-C3	H218	2,48	1,17	80	90	160	30	2	138,7	112,7	126
2218-K-TVH-C3	H318	3,18	1,36	80	90	160	40	2	139,4	111,5	126
1318-K-M-C3	H318	6,27	1,36	80	90	190	43	3	159,9	124,4	126
2318-K-M-C3	H2318	8,6	1,68	80	90	190	64	3	161	115,7	126
1219-K-M-C3	H219	3,28	1,32	85	95	170	32	2,1	148,2	120,5	125
2219-K-M-C3	H319	4,24	1,51	85	95	170	43	2,1	148,6	118,9	125
1319-K-M-C3	H319	7,2	1,51	85	95	200	45	3	170,5	127,7	125
2319-K-M-C3	H2319	9,97	1,89	85	95	200	67	3	168,5	121,6	133
1220-K-M-C3	H220	3,94	1,48	90	100	180	34	2,1	155,2	127,7	130
2220-K-M-C3	H320	5,1	1,69	90	100	180	46	2,1	156,9	124,4	130
1320-K-M-C3	H320	8,95	1,69	90	100	215	47	3	182,6	135,5	130
2320-K-M-C3	H2320	12,7	2,17	90	100	215	73	3	183	130,8	142
1222-K-M-C3	H222	5,49	1,9	100	110	200	38	2,1	173,9	140,7	145
2222-K-M-C3	H322	7,27	2,15	100	110	200	53	2,1	174,1	136,9	154
1322-K-M-C3	H322	12,2	2,15	100	110	240	50	3	203,2	154,7	154
2322-K-M-C3	H2322	17,5	2,74	100	110	240	80	3	203	145,5	154

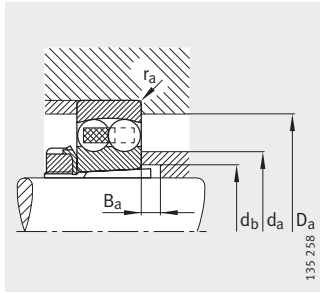

Mounting dimensions

		Mounting dimensions						Basic load ratings		Calculation factors				Fatigue limit load	Limiting speed	Reference speed
l	c	d _a	D _a	d _b	B _a	r _a	dyn. C _r	stat. C _{0r}	e	Y ₁	Y ₂	Y ₀	C _{ur}	n _G	n _B	
	≈	max.	max.	min.	min.	max.	N	N					N	min ⁻¹	min ⁻¹	
52	18	110	149	95	6	2	57 000	23 300	0,17	3,74	5,79	3,92	1 300	4 500	6 500	
65	18	108	149	96	10	2	71 000	28 500	0,27	2,33	3,61	2,44	1 580	4 300	5 700	
65	18	120	176	96	6	2,5	109 000	42 500	0,22	2,83	4,38	2,97	2 230	5 300	5 900	
86	18	112	176	100	6	2,5	156 000	57 000	0,39	1,63	2,53	1,71	3 000	5 000	5 800	
55	19	117	158	100	7	2,1	64 000	27 000	0,17	3,73	5,78	3,91	1 450	6 000	6 300	
68	19	114	158	102	9	2,1	84 000	34 000	0,27	2,32	3,59	2,43	1 840	6 000	5 600	
68	19	126	186	102	7	2,5	134 000	50 000	0,23	2,73	4,23	2,86	2 550	5 000	5 700	
90	19	117	186	105	7	2,5	167 000	63 000	0,38	1,66	2,57	1,74	3 250	4 800	5 500	
58	20	124	168	106	7	2,1	70 000	29 500	0,18	3,58	5,53	3,75	1 550	5 600	6 200	
71	20	120	168	108	8	2,1	98 000	40 000	0,27	2,33	3,61	2,44	2 120	5 600	5 600	
71	20	132	201	108	7	2,5	145 000	57 000	0,24	2,68	4,15	2,81	2 800	4 800	5 400	
97	20	125	201	110	7	2,5	196 000	78 000	0,38	1,67	2,58	1,75	3 900	4 500	5 200	
63	21	138	188	116	7	2,1	89 000	38 000	0,17	3,61	5,59	3,78	1 900	5 000	5 800	
77	21	132	188	118	6	2,1	126 000	51 000	0,28	2,23	3,45	2,33	2 550	5 000	5 300	
77	21	150	226	118	9	2,5	165 000	71 000	0,23	2,79	4,32	2,92	3 300	4 500	4 850	
105	21	139	226	121	7	2,5	221 000	94 000	0,37	1,69	2,62	1,77	4 400	4 300	4 500	



